



UNIVERSITY OF CAMBRIDGE INTERNATIONAL EXAMINATIONS
International General Certificate of Secondary Education

CANDIDATE
NAME

CENTRE
NUMBER

--	--	--	--	--

CANDIDATE
NUMBER

--	--	--	--	--

* 0 0 1 3 7 6 1 5 4 2 *

BIOLOGY

0610/61

Paper 6 Alternative to Practical

May/June 2012

1 hour

Candidates answer on the Question Paper

No Additional Materials are required.

READ THESE INSTRUCTIONS FIRST

Write your Centre number, candidate number and name on all the work you hand in.

Write in dark blue or black pen.

You may use a pencil for any diagrams or graphs.

Do not use staples, paper clips, highlighters, glue or correction fluid.

DO NOT WRITE IN ANY BARCODES.

Answer **all** questions.

At the end of the examination, fasten all your work securely together.

The number of marks is given in brackets [] at the end of each question or part question.

For Examiner's Use	
1	
2	
Total	

This document consists of **12** printed pages.



- 1 Some students investigated the effect of different conditions on onion leaves.

Fig.1.1 is a photograph of growing onion plants. They have tubular leaves that are hollow inside.

For
Examiner's
Use



Fig. 1.1

In an experiment an onion leaf was cut into three pieces each 2 cm long.

Four cuts were made in each piece as shown in Fig. 1.2.

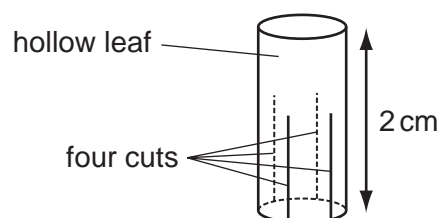

Fig. 1.2

The first piece was put into water.

The second piece was put into salt solution.



The third piece was put on dry filter paper.

The three pieces were left in their different conditions for 10 minutes after which the students made their observations.

Table 1.1 shows the shape of the pieces and how they felt when the students held them between their fingers.

For
Examiner's
Use

Table 1.1

in water	in salt solution	in air
		
springy, firm	soft, slimy	soft, limp

(a) (i) Explain the reasons for any differences that were observed.

.....

.....

.....

.....

.....

..... [3]

(ii) Suggest how this investigation could be improved.

.....

.....

.....

..... [2]

(b) Fig. 1.3 is a photomicrograph of a section through a tubular onion leaf.

For
Examiner's
Use

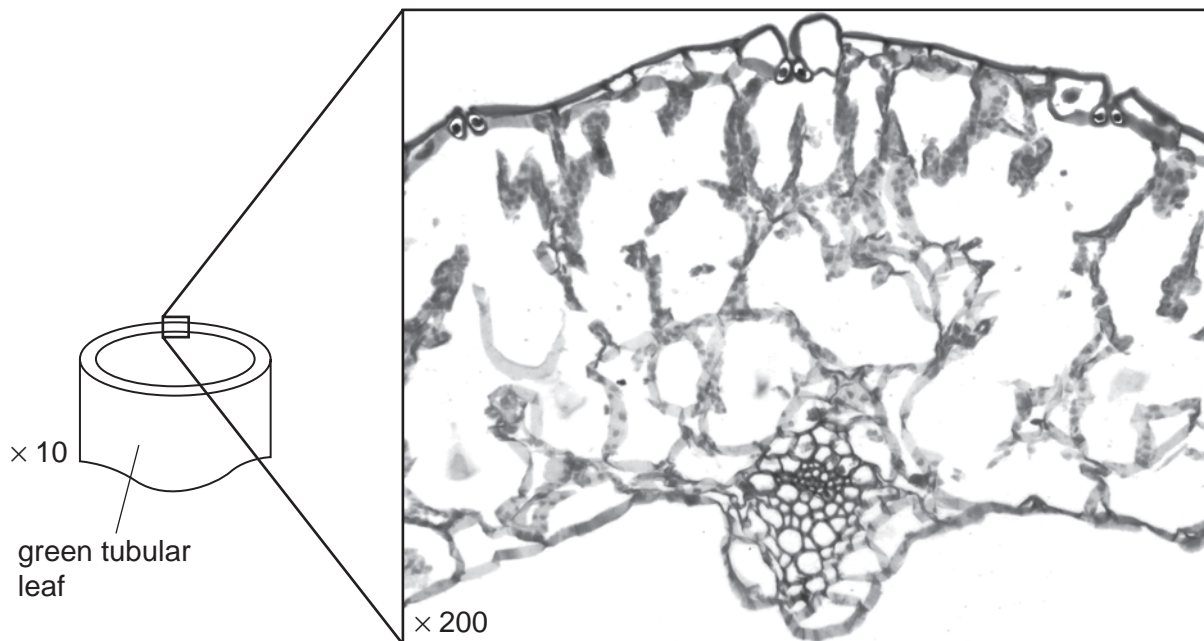

Fig. 1.3

(i) On Fig. 1.3, use lines and the letters **A**, **B** and **C** to label,

- A** - a mesophyll cell
- B** - a xylem vessel
- C** - an epidermal cell.

Draw the label lines with the letters **A**, **B** and **C** on Fig. 1.3. [3]

(ii) There are stomata on the leaf in Fig. 1.3. Draw a circle round **one** of them.

Draw the circle on Fig. 1.3. [1]

- (c) Fig. 1.4 shows a photograph of a section through the onion leaf. Its actual diameter was 5 mm.

For
Examiner's
Use

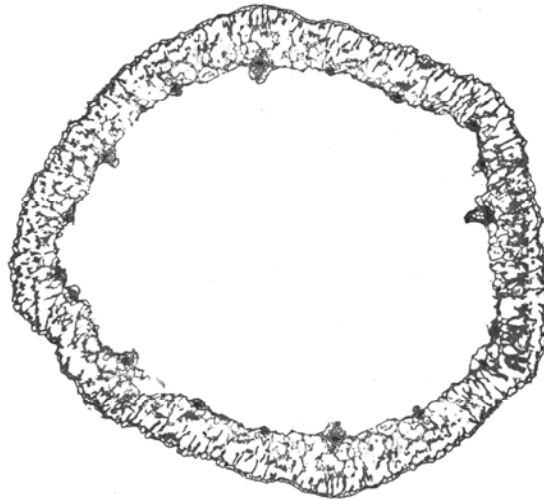

Fig. 1.4

Measure the diameter of the leaf shown in the photograph in Fig. 1.4.

diameter

Calculate the magnification of the onion leaf in the photograph in Fig. 1.4.

Show your working.

Magnification X [3]

(d) (i) Explain exactly how you would safely test another 2 cm piece of onion leaf for the presence of reducing sugar.

For
Examiner's
Use

.....
.....
.....
.....
.....
..... [3]

(ii) The reducing sugar test can tell you that:

- reducing sugar is absent
- reducing sugar is present at a low concentration
- reducing sugar is present at a high concentration

Explain how you can tell the difference between these possible results.

.....
.....
.....
.....
.....
..... [3]

(e) Onion leaves are green. Students testing onion leaves for the presence of starch used the method shown in the four stages of Fig. 1.5.

For
Examiner's
Use

Explain the reasons for the details shown in each stage. Write your answers on the lines below Fig. 1.5

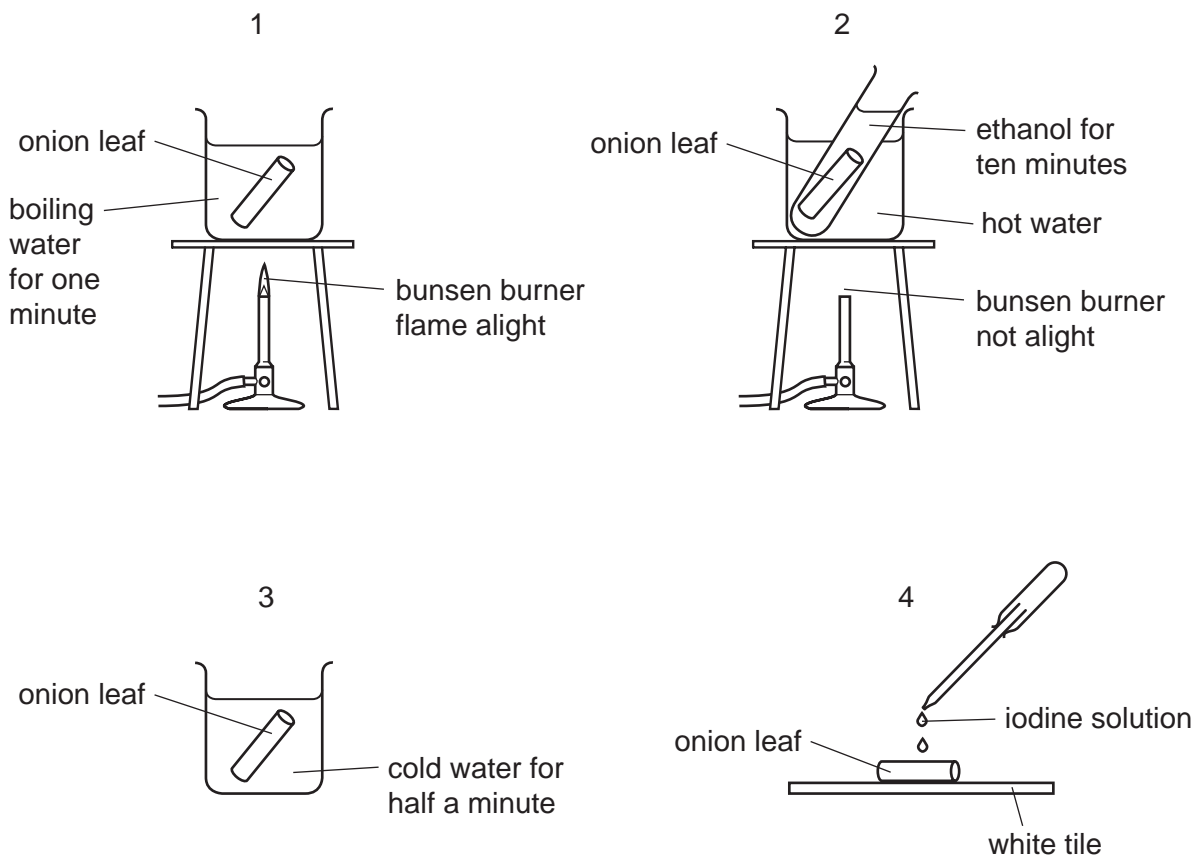

Fig. 1.5

reasons for stage 1

.....

reasons for stage 2

.....

reasons for stage 3

.....

reasons for stage 4

..... [4]

[Total: 22]

2 Fig. 2.1 shows three worms. One is a nematode.

For
Examiner's
Use

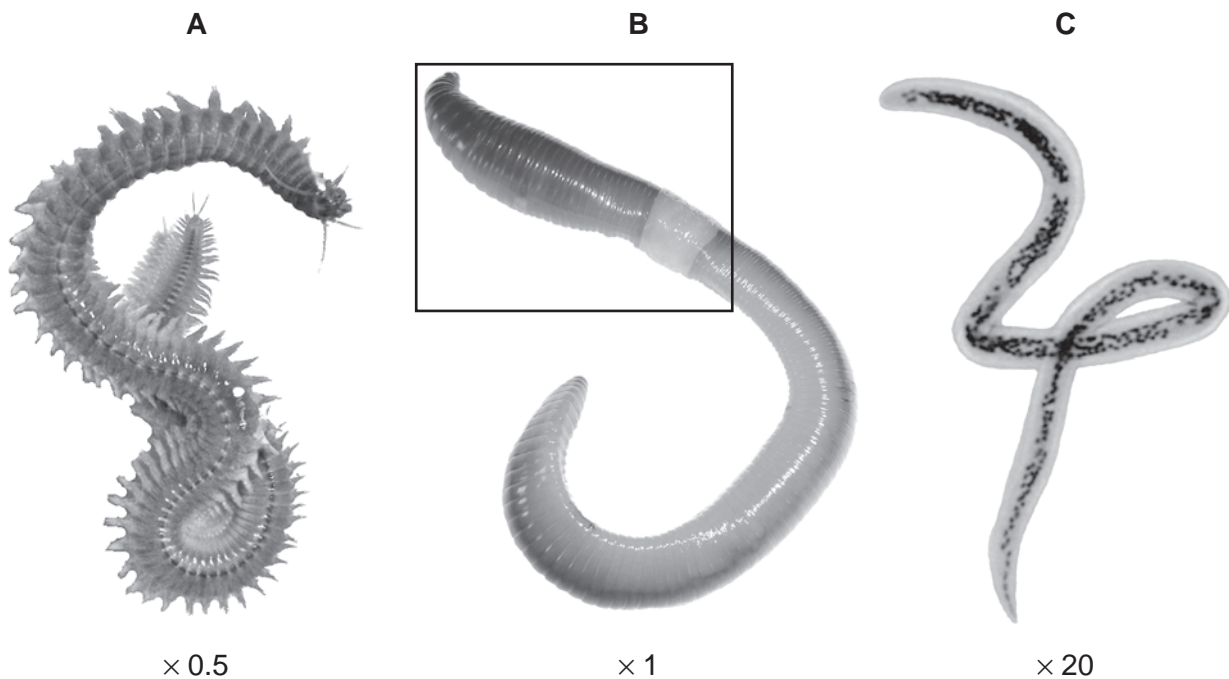

Fig. 2.1

(a) (i) Write the letter that identifies a nematode worm [1]

(ii) Give **two** reasons for your answer.

.....

.....

.....

..... [2]

(iii) The other two worms belong to a different group.

Name this group [1]

9

(b) Part of the worm labelled **B** is shown in a rectangle.

Make a large labelled drawing of this part of worm **B**.

*For
Examiner's
Use*

[4]

(c) Some students studied a population of 40 worms. They measured the lengths of 35 worms. These measurements are shown in Table 2.1.

For
Examiner's
Use

(i) Complete Table 2.1 by measuring the lengths of the five worms shown in Fig. 2.2. Use a ruler to measure them.

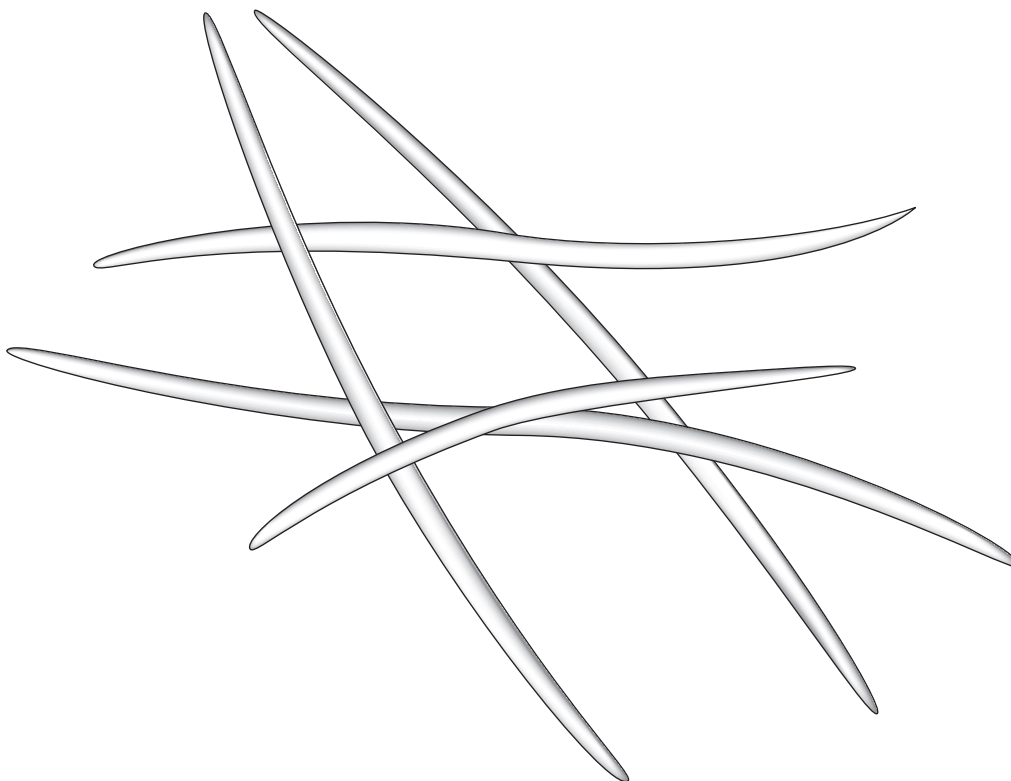

Fig. 2.2

Table 2.1

length/cm	7.0	8.1	10.8	6.2	11.4	9.0	10.3	12.1	13.5	5.6
-----------	-----	-----	------	-----	------	-----	------	------	------	-----

length/cm	11.3	7.9	12.9	7.4	13.1	13.7	15.5	8.8	14.1	15.2
-----------	------	-----	------	-----	------	------	------	-----	------	------

length/cm	9.6	8.4	14.7	16.0	7.2	10.5	9.2	12.4	6.7	13.3
-----------	-----	-----	------	------	-----	------	-----	------	-----	------

length/cm	14.0	11.6	12.6	12.2	8.3					
					

Record the length of each worm in Table 2.1 [2]

- (ii) Complete the tally chart, Table 2.2, to show the number of worms in each range of lengths.

For
Examiner's
Use

Table 2.2

range of lengths / cm	tally	frequency
5.0 - 6.9
7.0 - 8.9
9.0 - 10.9
11.0 - 12.9
13.0 - 14.9
15.0 - 16.9

[3]

- (iii) Use the data from Table 2.2 to plot a histogram showing the frequency of each range of lengths.

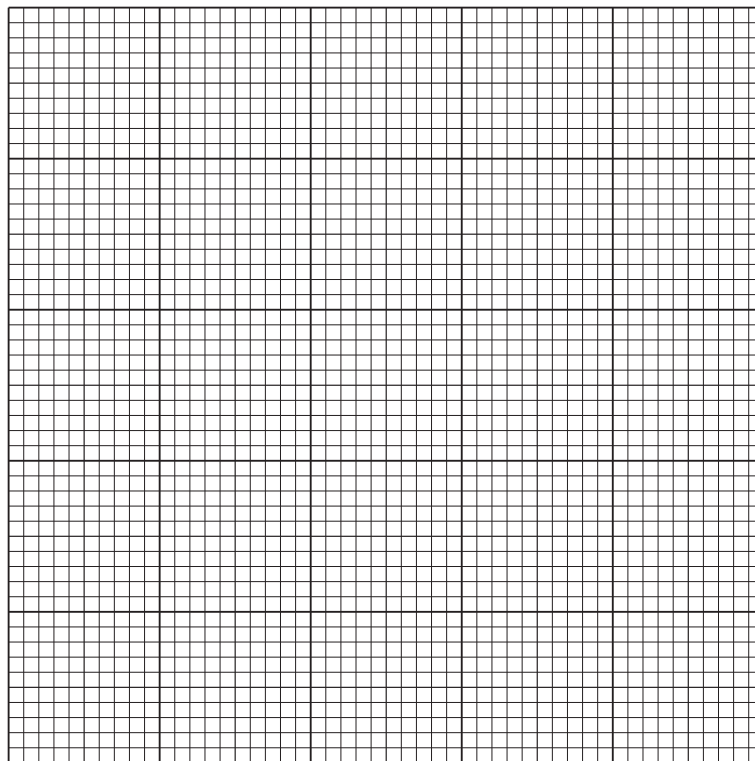

[4]

Question 2 continues on page 12

(iv) Suggest a reason for the shape of the histogram.

.....
..... [1]

[Total: 18]

Copyright Acknowledgements:

Permission to reproduce items where third-party owned material protected by copyright is included has been sought and cleared where possible. Every reasonable effort has been made by the publisher (UCLES) to trace copyright holders, but if any items requiring clearance have unwittingly been included, the publisher will be pleased to make amends at the earliest possible opportunity.

University of Cambridge International Examinations is part of the Cambridge Assessment Group. Cambridge Assessment is the brand name of University of Cambridge Local Examinations Syndicate (UCLES), which is itself a department of the University of Cambridge.